

**Wayne Bruce**  
Director of Communications



## Her Majesty Queen Elizabeth II

All at Bentley Motors are deeply saddened to hear of the passing of Her Majesty The Queen.

Our sincere sympathies extend to The Royal Family.

God save the King.







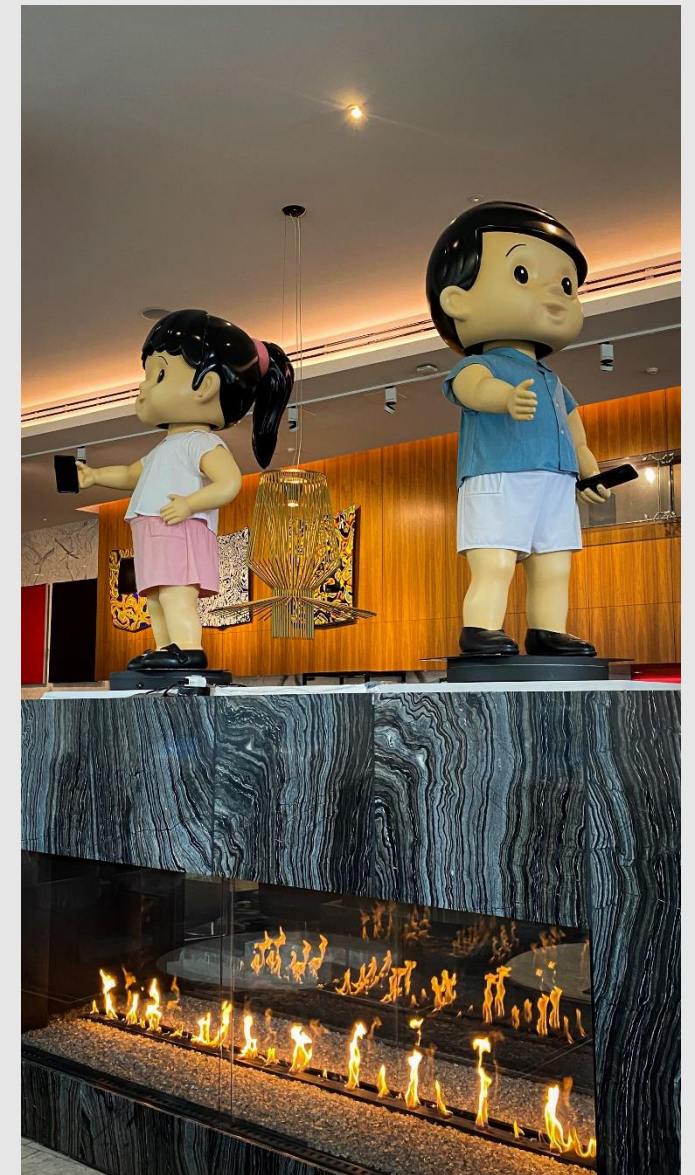



### RECORD SALES & REVENUE

- €398m half-year profit
- Revenue per car climbs to €213k
- 23.3% return on sales



### ROBUST BUSINESS STRATEGY

- Five-in-Five plan
- £2.5 billion investment
- Carbon neutrality by 2030



### EXPANSION OF PRODUCT

- New Azure range focused on wellness
- New S range delivers driving performance
- First luxury brand to offer range of Hybrids



SPEED SIX CONTINUATION

- 12 cars
- £1.5m + tax each
- All sold



BENTLEY MULLINER BATUR

- 18 cars
- £1.65m + tax each
- All sold



FLYING SPUR SPEED

- Last W12 powered Flying Spurs
- Unique design cues
- Maximum performance



- Preview of the vessel for future whisky
- Partnership founded in sustainability
- More news soon



- First company to secure status
- Charts use, reduction and recycling through the value chain
- Scale-up of plastic reduction to come



- Bentley Residence to include Dezervator lift
- In-unit garages with EV charging points
- Building complete in 2026





BENTAYGA V8



BENTAYGA HYBRID

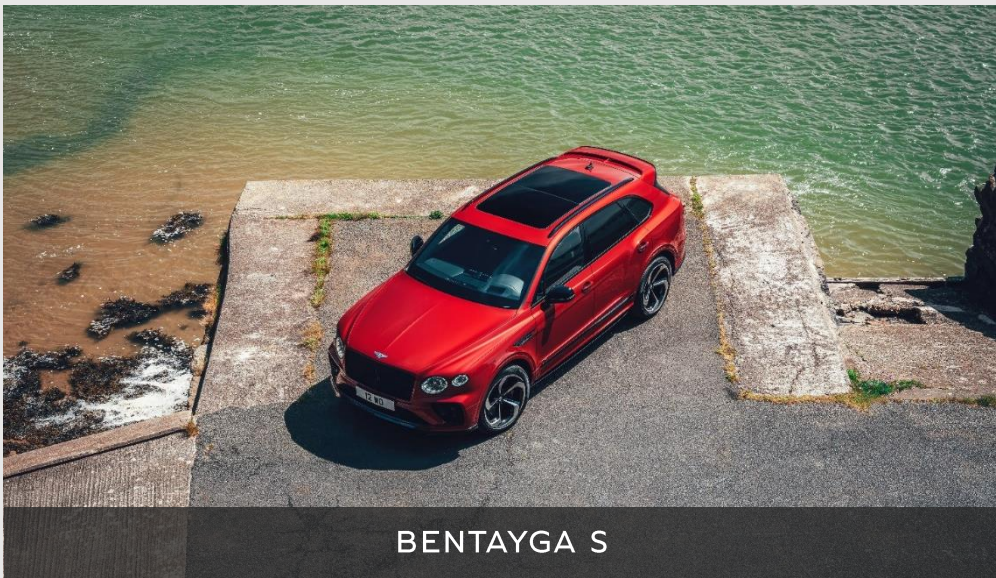

BENTAYGA S



BENTAYGA SPEED



OFF-ROAD ABILITY



MOTORSPORT



ELECTRIFIED LUXURY

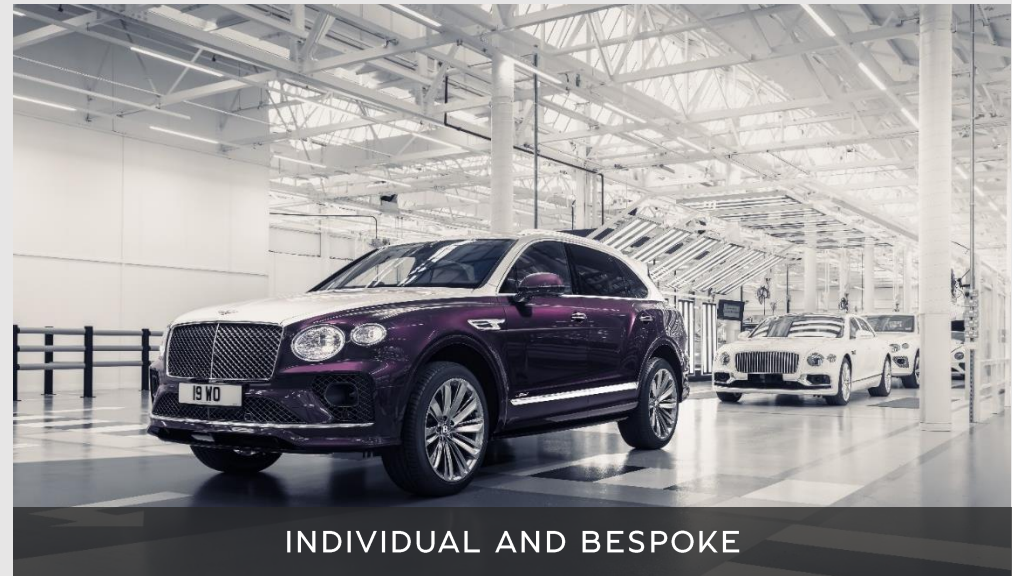

INDIVIDUAL AND BESPOKE

## Positioning

The rise of the luxury SUV  
and fall of the luxury sedan

Raising the ceiling of the D-segment –

Bentayga EWB takes the place of the  
Mulsanne as the pinnacle luxury product.



## Testing and Development Engineering and Building

More than just a stretch – the Bentayga EWB has been a nine-digit investment to create the pinnacle luxury SUV.



2,500 NEW PARTS



TESTING

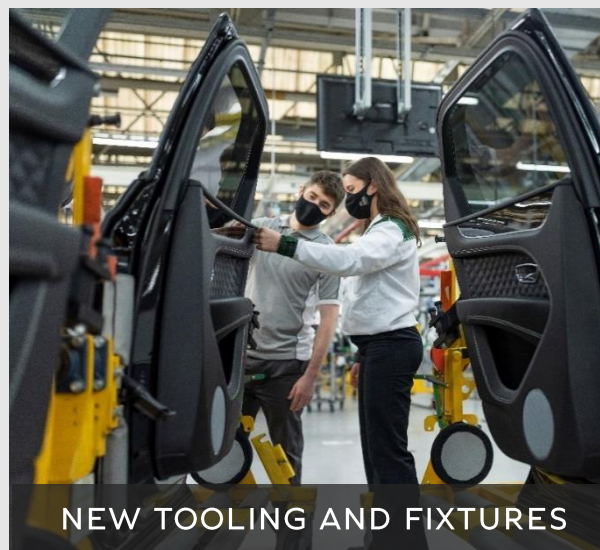

NEW TOOLING AND FIXTURES



MODIFIED BUILD HALL



**Powertrain:**

4.0 litre twin turbocharged V8 (3996 cc)

**Transmission:**

8 speed dual clutch | active AWD

**Peak Power:**

404 kW / 550 PS / 542 BHP @6000 rpm

**Peak Torque:**

770 Nm / 568 lb.ft @2000 – 4500 rpm

**Acceleration:**

0-60 mph in 4.5 secs (0-100km/h in 4.6 secs)

**Maximum Speed:**

180 mph / 290 km/h

**Turning Circle (Kerb to Kerb)**

11.8m

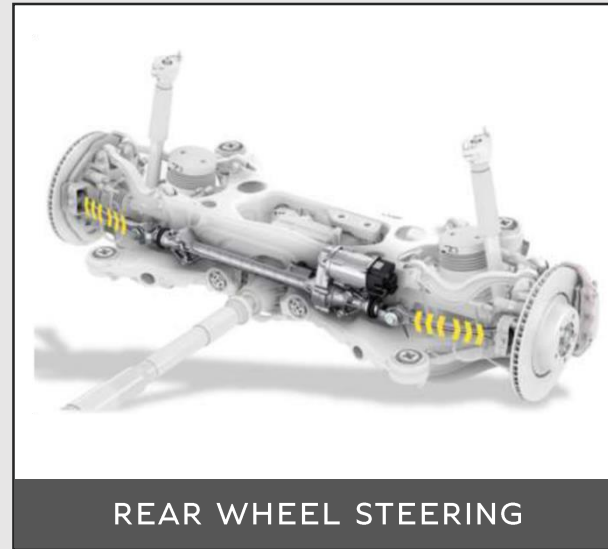
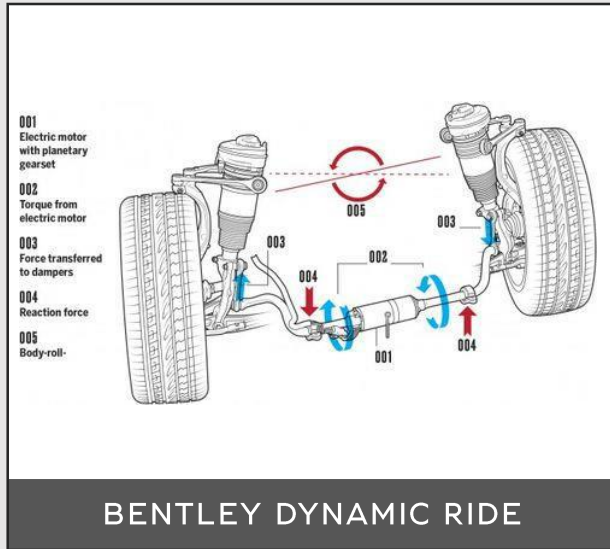

## Drive and Be Driven A Chassis for Both

Bentayga EWB retains the exceptional driving credentials of the Bentayga V8, thanks to latest-generation chassis technology.

Despite being 180 mm longer, Bentayga EWB has a smaller turning circle than a Bentayga V8.

## Exterior Design Zero Compromise

Detail changes to mark the new model, without changing the second-generation Bentayga aesthetic.

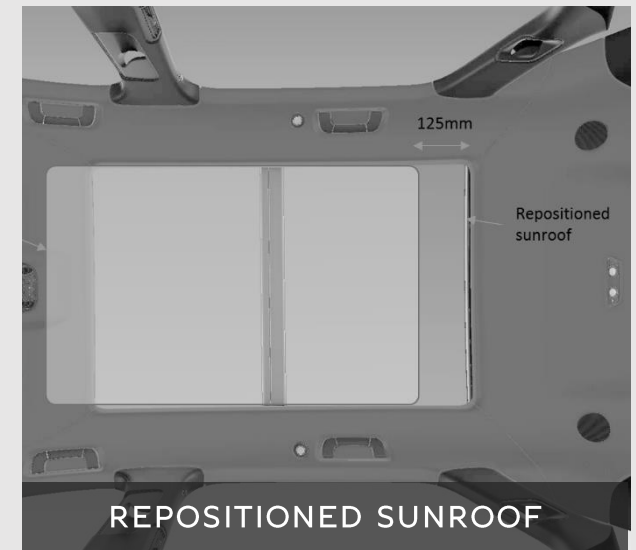



## Interior Design

### Crafted Detail, Seamless Tech

New heights of craftsmanship combine with hidden technological integration, while the extended wheelbase provides class-leading rear legroom.



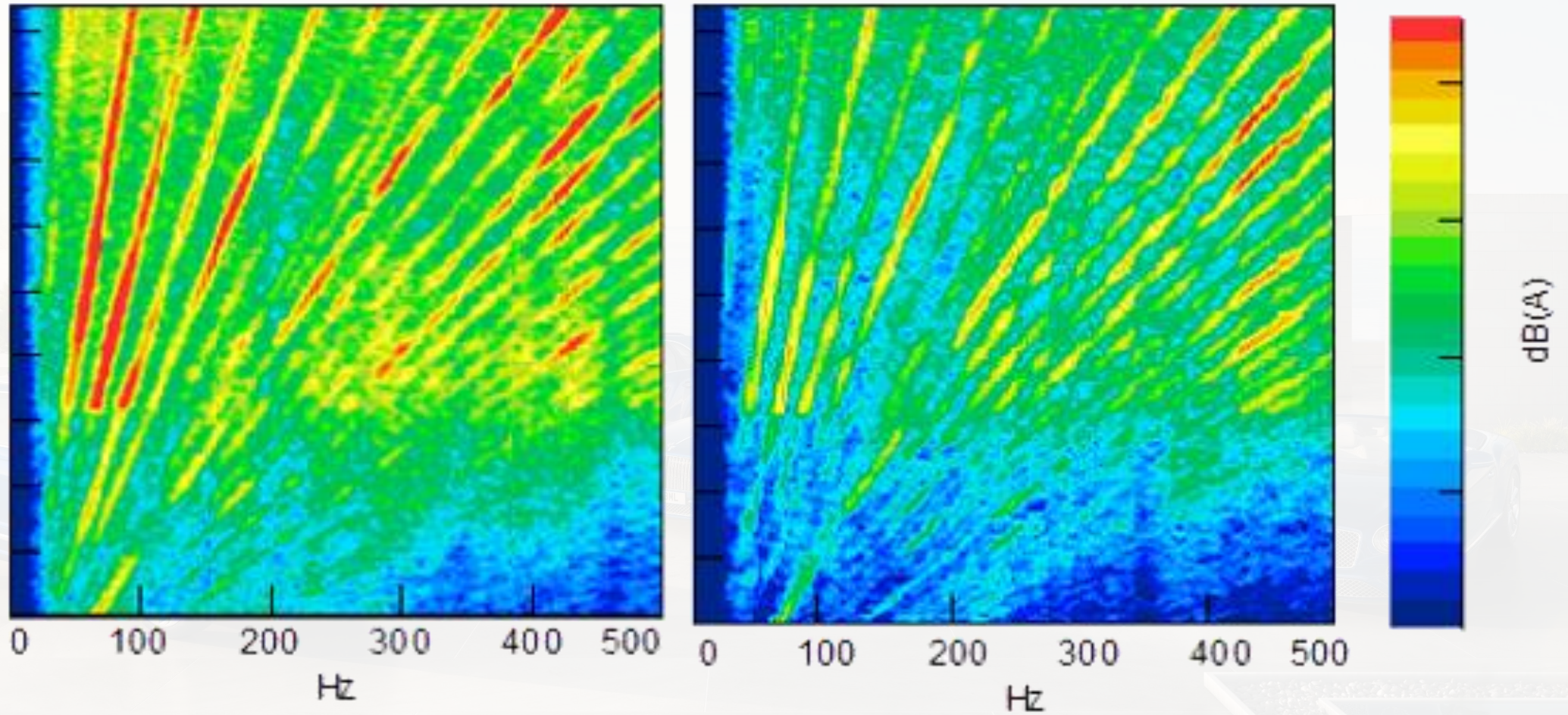

AZURE RANGE – FOCUS ON WELLBEING

## Airline Seat Specification The Advancement of Wellness

The most advanced seat ever fitted to a car, with 22-ways of adjustment, auto climate sensing and postural adjustment.



BUSINESS MODE



RELAX MODE



SEAT AUTO CLIMATE

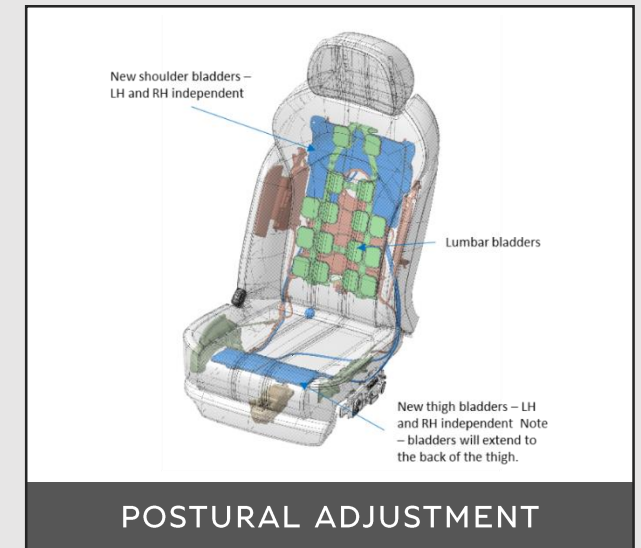

POSTURAL ADJUSTMENT





## Dual Rear Air Ionisers Optimum Cabin Air Quality

Separate air ionisation system for rear cabin, with rear occupant detection, removes airborne particulates.

# Drive Day Overview | Morning

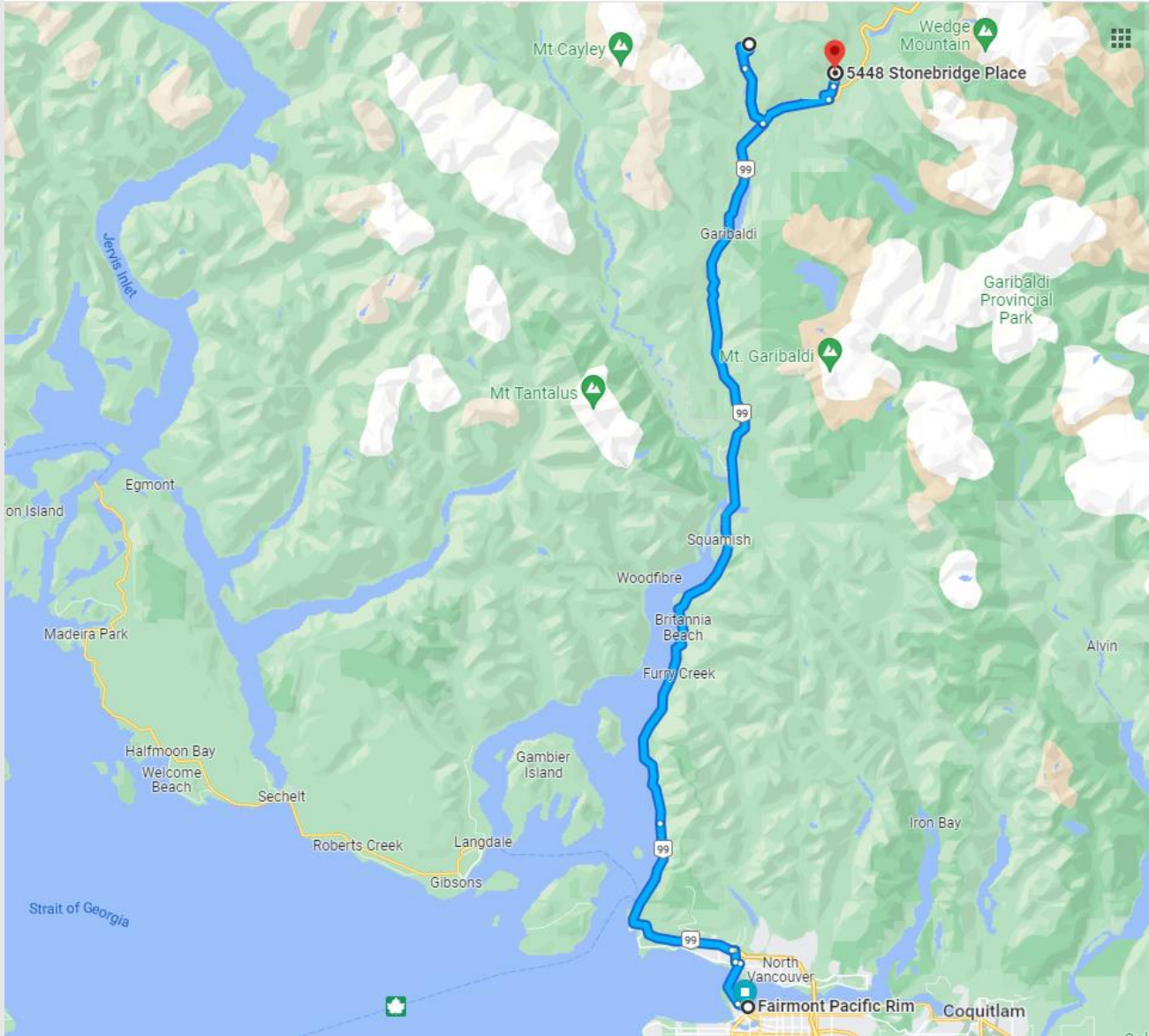

## Drive Day Overview | Destination

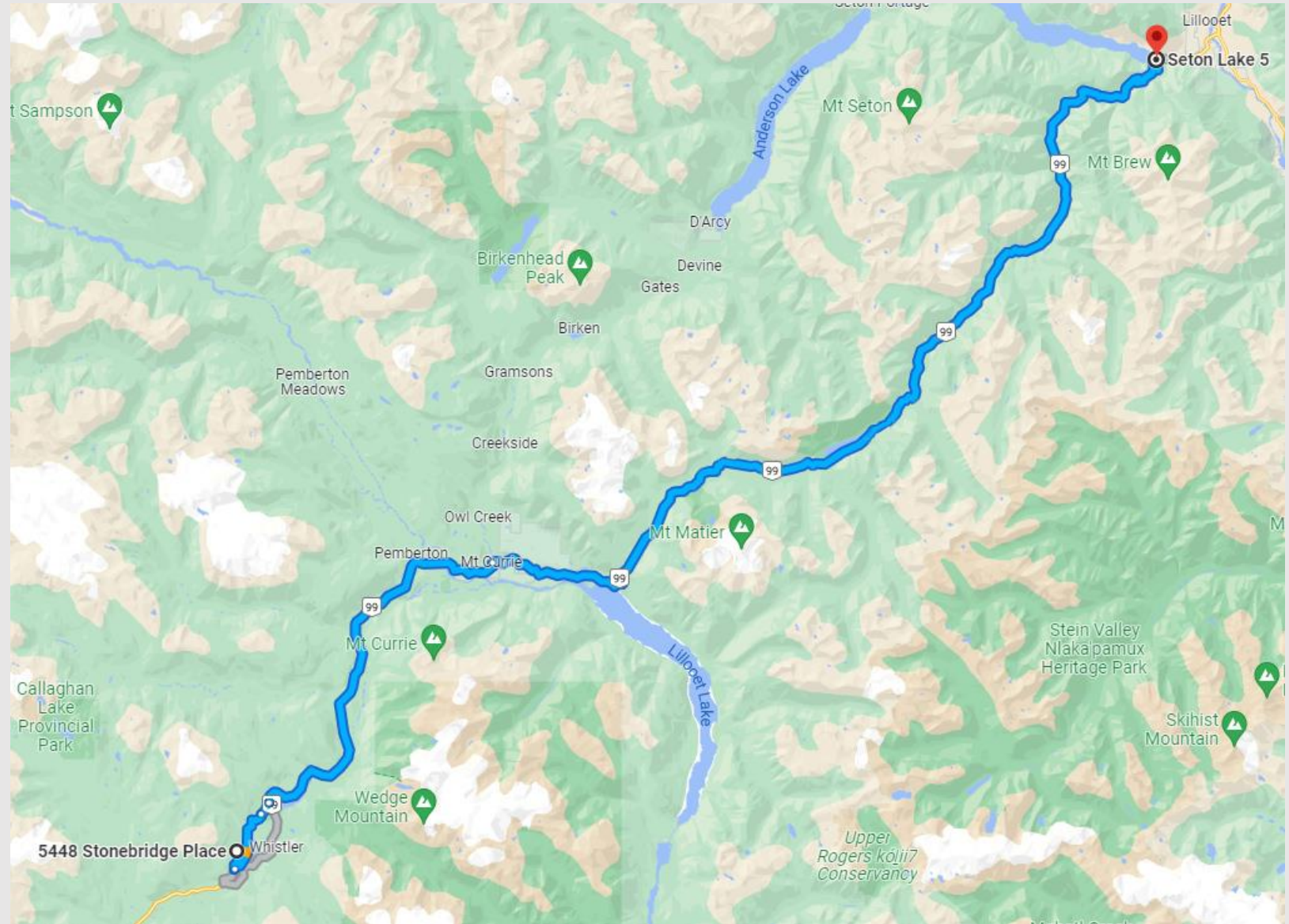

Style	Exterior	Main Hide	Secondary Hide	Veneer
Extroverted	Camel	Imperial Blue	Imperial Blue	Dark Tint Aluminium
Artistic	Portofino	Saddle	Beluga	Open Pore Crown Cut Walnut
Urban	Dove Grey	Cricket Ball	Cricket Ball	Dark Fiddleback Eucalyptus
Serene	Cumbrian Green	Portland	Cumbrian Green	Liquid Amber with metal inserts
Timeless	Marlin	Linen	Brunel	Piano Linen with metal inserts
Exquisite	Damson	Porpoise	Damson	Dark Tint Aluminium

Azure  
4+1 seat  
Blackline



First Edition  
4-seat Airline  
Bright chrome



**Reminder – Drive Impressions Embargo**  
00:01 BST, Wednesday 28 September

**Bentley Newsroom – Content Portal**  
[www.bentleymedia.com](http://www.bentleymedia.com)  
Password: VancouverEWB

**#BentaygaEWB #BentleyNewsroom**  
Please use the hashtag so we can  
promote your posts

